



Move cars effortlessly with our forklift car mover attachment, designed to securely lift and transport vehicles using a forklift truck.

Featuring articulating arms for safe and damage-free car grabbing, this attachment is equipped with an oilite bearing for smooth pivoting of the head.

With a 2000kg safe working load capacity and adjustable arm spacing, our car mover ensures efficient and safe handling of various car makes, models, and sizes without the need for a driver, allowing for closer parking arrangements.

<b>Model Ref: FM-CAR-MOVER</b>	
<b>Capacity (kg)</b>	2000
<b>Max Fork Section (mm)</b>	140 x 60
<b>Horizontal C of G (mm)</b>	1219
<b>Weight (kg)</b>	133

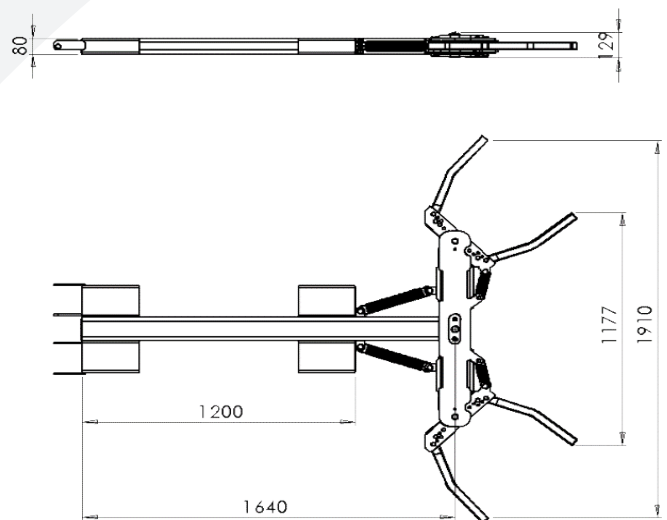

## Features & Benefits

- Mechanical design perfect for garages, body shops, scrap yards & impound yards
- Low profile designed for easy access under front bumper of vehicle
- Simple mechanical operation utilising two articulating arms to grab a car safely without causing tyre damage
- Oilite bearing enables the head to pivot, ensuring the vehicle can be towed once lifted
- Spring loaded arms return to their original position ensuring the unit is simple to use
- Universal design to fit majority of vehicles

